

THE
WARRIOR CAM CO.

EAST HARTFORD, CONNECTICUT

12-

HARTFORD CLAMPS

Single and Double Steel Bar Clamps

QUICKER · STRONGER · MORE DURABLE

CATALOG No. 60 & 61

Manufactured by

The Hartford Clamp Co.

466 Park Avenue

EAST HARTFORD 8, CONN.

Why HARTFORD CLAMPS

are recommended by thousands of users

Long
Life

Hartford Patented **Single Bar** Clamps have bars made of high carbon spring steel rolled to our own special analysis, assuring strength and durability. The **Double Bar** Clamps have side bars of solid cold drawn steel. All our castings are of the best refined malleable iron, screws are made of cold drawn steel having hardened thrust bearing at end of screw to prevent wearing through the push plate. Dogs and pins are double heat treated and hardened. There are no notches in the bars to weaken them. Many of our clamps are still in use after twenty years of service, which proves their superiority.

Time
and
Labor
Saving

Having no notches to screw up the difference between, **Hartford** Patented Clamps can be quickly and easily adjusted to the work. The locking device is simple, but positive, and will lock on any part of the bar—the more pressure applied the firmer the grip. When screw pressure is released, the tail piece can be easily moved—jamming or sticking is impossible—the clamp is then ready for the next piece of work. (See next page.)

Cuts
Costs

Hartford Clamps, which are moderately priced, last longer—replacement parts seldom needed. By having the proper clamps for your particular job both money and time are saved.

The United States Government, Woodworkers, Schools, Machine Shops, Body Builders, Casket Manufacturers and many others are satisfied users of our various types of clamps.

MANUFACTURERS OF CLAMPS SINCE 1915

THE HARTFORD CLAMP COMPANY

The HARTFORD

IMPROVED LOCKING DEVICE

SINGLE AND DOUBLE BAR CLAMPS

(Patented)

The **Hartford** Locking Device is of simple construction consisting of pin, dog, spring and casting. The dog and pin are of special heat treated, hardened steel which practically eliminates wear. The strong spiral spring, which will outlast the clamp, holds the dog or cam against the bar and permits instant adjustment at any point on the bar, and under any pressure. Slipping or sticking is impossible.

The Locking Device is of the same construction on both the Single and Double Bar Clamps, except that there are two cams on the Double Bar Clamps, one pressing on each bar, giving perfect locking action and an even pull.

All parts are interchangeable and can be easily replaced if necessary.

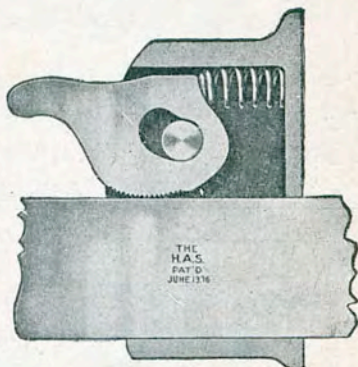

THE DEEP ENGAGEMENT CLAMP LOCKING DEVICE

(Patented)

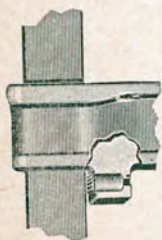

This locking device instantly locks when pressure is applied and will not slip or stick. Hammering or any other vibration will not loosen it from the work—it can only be removed by the loosening of the screw.

As seen in the cut, it is impossible for the locking mechanism to get out of order, as the gripping block is made of double heat treated, hardened steel and is inserted firmly in the casting. The gripping block can be easily replaced if necessary.

EAST HARTFORD, CONNECTICUT

Page Three

The HARTFORD

QUICK ADJUSTING, SELF-LOCKING AND UNLOCKING SINGLE BAR CLAMPS (Patented)

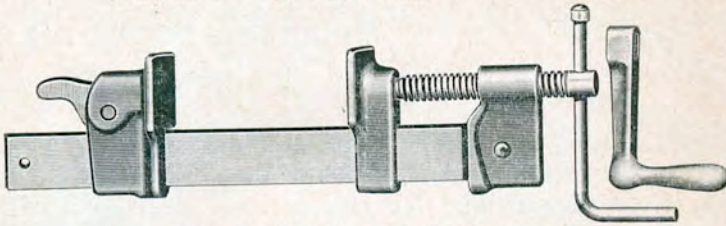

Specifications Style No. 5

Bar $1\frac{1}{2}'' \times \frac{1}{4}''$ Screw $11/16''$ Dia.
 Clamping Surface $2''$ h. x $1\frac{3}{4}''$ w. Handle loose or fixed
 Tested to a safe clamping strain of 7,000 lbs.

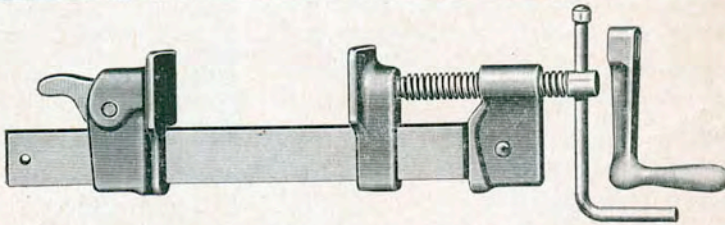

Specifications Style No. 7

Bar $1\frac{3}{4}'' \times 5/16''$ Screw $3/4''$ Dia.
 Clamping Surface $2\frac{1}{2}''$ h. x $2''$ w. Handle loose or fixed
 Tested to a safe clamping strain of 8,000 lbs.

These two general purpose clamps are used for interior woodworking, body building and in the manufacture of furniture, sash and doors.

Bars are of high carbon spring steel. All castings are of the best grade malleable iron. Screws have deep cut ACME THREADS. Hardened thrust bearing at end of screw prevents wear.

STYLE No. 5

Stock No.	Opens	Approx. Net Wt. Doz.
524	2 ft.	75 lbs.
530	$2\frac{1}{2}$ ft.	83 lbs.
536	3 ft.	91 lbs.
548	4 ft.	107 lbs.
560	5 ft.	123 lbs.
572	6 ft.	139 lbs.
584	7 ft.	155 lbs.
596	8 ft.	171 lbs.
5108	9 ft.	187 lbs.
5120	10 ft.	203 lbs.

STYLE No. 7

Stock No.	Opens	Approx. Net Wt. Doz.
724	2 ft.	105 lbs.
730	$2\frac{1}{2}$ ft.	116 lbs.
736	3 ft.	127 lbs.
748	4 ft.	149 lbs.
760	5 ft.	171 lbs.
772	6 ft.	194 lbs.
784	7 ft.	216 lbs.
796	8 ft.	238 lbs.
7108	9 ft.	261 lbs.
7120	10 ft.	283 lbs.

Packed one-half dozen to a bundle

SEE PRICE LIST

THE HARTFORD CLAMP COMPANY

The HARTFORD

QUICK ADJUSTING, SELF-LOCKING AND UNLOCKING SINGLE BAR CLAMPS (Patented)

Where it is necessary to have a clamp that will reach in up to 3" and still be rigid enough in construction to stand a fairly heavy strain we offer our No. 14.

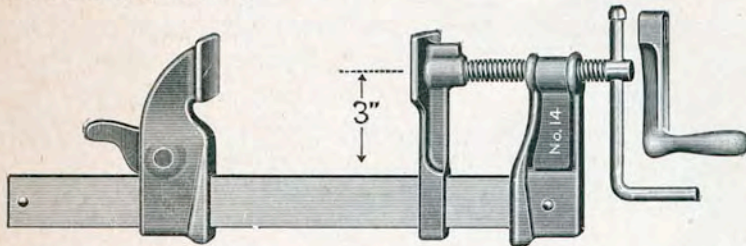

This clamp available in a heavier pattern.

Style No. 141
Price on request.

No. 14

Specifications Style No. 14

Bar Size	1 1/2" x 1/4"	Screw	5/8" Dia.
Reach	3"	Handle	loose or fixed
Clamping Surface 1 3/4" h. x 1 5/8"			

The No. 55 Notched Bar Clamp below is of simple construction and choice of some of our customers.

The screws in both these clamps have ACME THREADS with hardened thrust bearing at end of screw which prevents wearing through push plate.

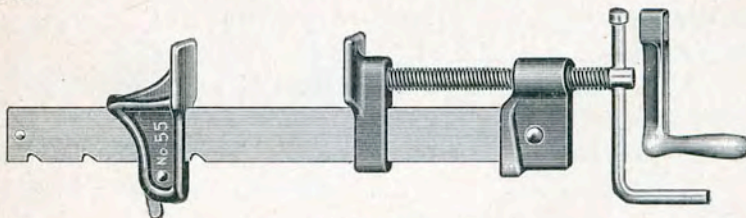

No. 55

Specifications Style No. 55

Bar Size	1 1/2" x 1/4"	Screw	5/8" Dia.
Clamping Surface	2" h. x 1 3/4"	Handle	loose or fixed

Style No. 14

Style No. 55

Stock No.	Opens	Approx. Net Wt. Doz.	Stock No.	Opens	Approx. Net Wt. Doz.
1424	2 ft.	84 lbs.	5524	2 ft.	75 lbs.
1430	2 1/2 ft.	92 lbs.	5530	2 1/2 ft.	83 lbs.
1436	3 ft.	99 lbs.	5536	3 ft.	91 lbs.
1448	4 ft.	115 lbs.	5548	4 ft.	107 lbs.
1460	5 ft.	130 lbs.	5560	5 ft.	123 lbs.
1472	6 ft.	145 lbs.	5572	6 ft.	139 lbs.

Packed one-half dozen to a bundle

SEE PRICE LIST

EAST HARTFORD, CONNECTICUT

The HARTFORD

QUICK ADJUSTING, SELF-LOCKING AND UNLOCKING SINGLE BAR CLAMPS (Patented)

For lighter work where the clamping strain need not be too great, we recommend our **No. 1** and **No. 58** clamps. Made with the best grade malleable iron castings, high carbon spring steel bars and screws with deep cut ACME THREADS.

They are similar in construction to our No. 5 except they are smaller and lighter and have the same simple but positive **HARTFORD** locking mechanism (see page 3). These clamps are the best you can buy for light or average work.

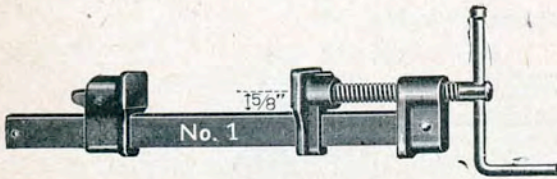

Specifications Style No. 1

Bar 1" x 5/16"
Clamping Surface 1 3/8" h. x 1 3/4" w.
Screw 9/16" Diameter
Handle loose or fixed

Specifications Style No. 58

Bar 1 1/8" x 3/16"
Clamping Surface 1 3/8" Sq
Screw 1/2" Diameter
Handle wheel only



Style No. 1

Stock No.	Opens	Approx. Net Wt. Doz.
112	1 ft.	46 lbs.
118	1 1/2 ft.	52 lbs.
124	2 ft.	58 lbs.
130	2 1/2 ft.	65 lbs.
136	3 ft.	71 lbs.

Style No. 58

Stock No.	Opens	Approx. Net Wt. Doz.
5812	1 ft.	36 lbs.
5818	1 1/2 ft.	40 lbs.
5824	2 ft.	44 lbs.
5830	2 1/2 ft.	48 lbs.
5836	3 ft.	52 lbs.

Packed one-half dozen to a bundle

SEE PRICE LIST

THE HARTFORD CLAMP COMPANY

The HARTFORD

QUICK ADJUSTING, SELF-LOCKING AND UNLOCKING DOUBLE BAR CLAMPS (Patented)

“HARTFORD” Double Bar Clamps are made of the highest quality materials. Castings are of the best grade malleable iron — side bars are SOLID COLD DRAWN STEEL — Screw has ACME THREADS. A hardened thrust bearing is inserted in the push plate at end of screw to prevent its wearing through. The loose sliding handle is used in order that the clamps may be placed snug against each other if necessary.

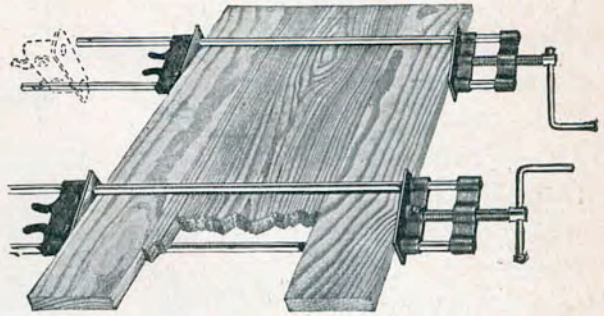

A Double Bar Clamp will stand a much greater strain than the single bar clamp as there is a bar on each side of the work. They are quick to apply by slipping over the end of the work. For center work the tail piece is taken off the short bar (while still held by the long bar), clamp placed over the work and the tail piece replaced.

They are especially adapted to THIN work as they PREVENT BUCKLING. Specialists claim they are the best clamp for heavy work as the double bar gives equal pull on both sides of the work.

The “HARTFORD” DOUBLE BAR CLAMP is easy to operate with the “Hartford” Patented Locking Device—it cannot slip—is quick adjusting, self-locking and unlocking.

Specifications Style No. 3

Bars	1/2" diameter	Clamping Surface	2 1/8" wide
Space between bars	3 1/4"	Handle	loose only
Screw	11/16" diameter		

Style No. 3

Stock No.	Opens	Approx. Net Wt. Doz.	Stock No.	Opens	Approx. Net Wt. Doz.
324	2 ft.	89 lbs.	360	5 ft.	136 lbs.
336	3 ft.	105 lbs.	372	6 ft.	152 lbs.
348	4 ft.	120 lbs.	384	7 ft.	168 lbs.

Packed one-half dozen to a bundle

SEE PRICE LIST

EAST HARTFORD, CONNECTICUT

The HARTFORD

QUICK ADJUSTING, SELF-LOCKING AND UNLOCKING DOUBLE BAR CLAMPS (Patented)

STYLE No. 6 is built stronger than the No. 3 double bar clamp, as it has heavier side bars and a $\frac{7}{8}$ "—5 pitch ACME THREADED SCREW. This clamp is used for gluing posts, veneering door stiles, chair arms, butcher blocks and heavy cutting tables.

The locking device is the same on our double bar clamps as on the single bar clamps and will lock on any part of the bar.

Locking mechanism shown on Page 3.

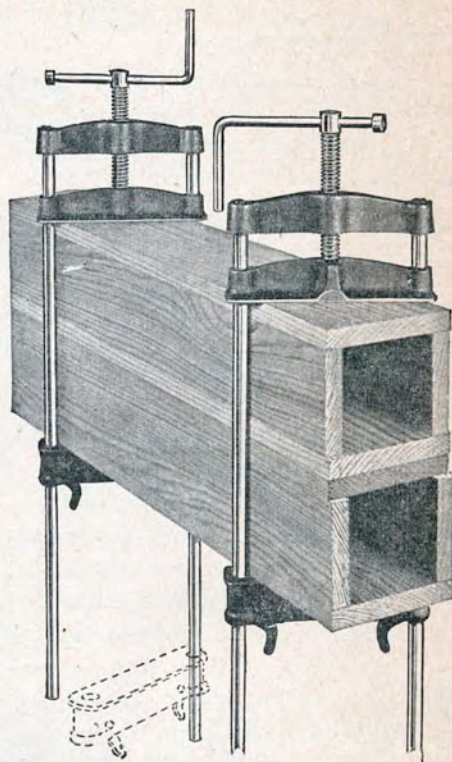

Specifications Style No. 6

Bars	$\frac{5}{8}$ " Diameter
Space between bars	$6\frac{3}{4}$ "
Screw	$\frac{7}{8}$ " Diameter
Clamping Surface	$2\frac{1}{8}$ " wide
Handle	loose only

Style No. 6

Stock No.	Opens	Approx. Net Wt. Doz.
6H24	2 ft.	184 lbs.
6H36	3 ft.	208 lbs.
6H48	4 ft.	232 lbs.
6H60	5 ft.	256 lbs.
6H72	6 ft.	280 lbs.

Packed one-half dozen to a bundle

SEE PRICE LIST

THE HARTFORD CLAMP COMPANY

The HARTFORD

QUICK ADJUSTING, SELF-LOCKING AND UNLOCKING PIPE CLAMP FIXTURES (Patented)

STYLE No. 52 Pipe Clamp Fixtures are made to fit $\frac{3}{4}$ " pipe, and the **STYLE No. 53** to fit $\frac{1}{2}$ " pipe, regular or extra heavy-black pipe preferable. Heavy castings have standard pipe threads which eliminates the need of tools in attaching to pipe, or in transferring of fixtures from one length of pipe to another. The castings of **BEST GRADE MALLEABLE IRON** are enameled. The screws are of cold drawn steel having deep cut **ACME THREADS** to insure long life.

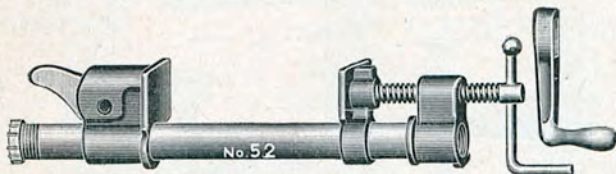

Specifications Style No. 52

Fixtures ONLY Fits $\frac{3}{4}$ " pipe
Pipe NOT furnished
Clamping Surface $1\frac{3}{4}$ " Square
Screw $\frac{9}{16}$ " Dia.
Handle Loose or fixed

Approximate net weight, per dozen sets, loose handles, 25 lbs:
Fixed Handles, 28 lbs.

Packed 2 sets per shelf box and 6 shelf boxes per carton.

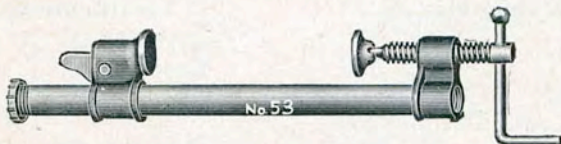

Specifications Style No. 53

Fixtures ONLY Fits $\frac{1}{2}$ " pipe
Pipe NOT furnished
Clamping Surface $1\frac{1}{4}$ " Dia. Button
Screw $\frac{9}{16}$ " Dia.
Handle Loose only

Approximate weight, per dozen sets, 14 lbs.

Packed 2 sets per shelf box and 12 shelf boxes per carton.

SEE PRICE LIST

EAST HARTFORD, CONNECTICUT

The HARTFORD

QUICK ACTING DEEP ENGAGEMENT CLAMPS

All of our DEEP ENGAGEMENT CLAMPS are sturdily constructed. The deep cut ACME THREADED screws are made of cold drawn steel. The wooden handles are made to fit the hand. The locking device instantly locks when pressure is applied and will not slip or stick. Hammering or any other vibration will not loosen the locking device. These clamps are made for long hard usage. For DEEP ENGAGEMENT LOCKING Device see page 3.

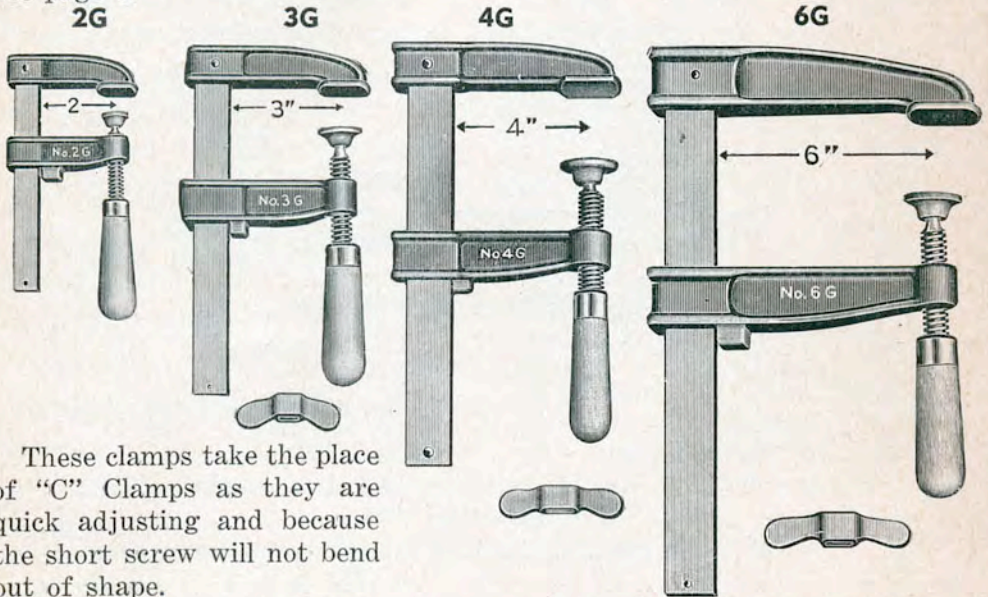

These clamps take the place of "C" Clamps as they are quick adjusting and because the short screw will not bend out of shape.

Specifications Style No. 2G

Bar Size $\frac{5}{8}$ " x $\frac{3}{16}$ "
 Reach 2"
 Clamping Surface $\frac{11}{16}$ " Dia. Button
 Screw $\frac{3}{8}$ " Dia.
 Handle Wood only

Style No. 2G

Stock No.	Opens	Approx. Net Wt. Doz.
2G4	4 in.	8 lbs.
2G6	6 in.	9 lbs.
2G8	8 in.	10 lbs.
2G10	10 in.	11 lbs.
2G12	12 in.	12 lbs.
2G18	18 in.	15 lbs.
2G24	24 in.	18 lbs.

Specifications Style No. 3G

Bar Size 1" x $\frac{1}{4}$ "
 Reach 3"
 Clamping Surface $\frac{11}{4}$ " Dia. Button
 Screw $\frac{9}{16}$ " Dia.
 Handle Wood or wing

Style No. 3G

Stock No.	Opens	Approx. Net Wt. Doz.
3G6	6 in.	24 lbs.
3G8	8 in.	26 lbs.
3G10	10 in.	28 lbs.
3G12	12 in.	30 lbs.
3G18	18 in.	35 lbs.
3G24	24 in.	40 lbs.
3G30	30 in.	45 lbs.

Packed one-half dozen to a carton or bundle

SEE PRICE LIST

THE HARTFORD CLAMP COMPANY

The HARTFORD

EDGE CLAMP ATTACHMENTS

The EDGE CLAMP ATTACHMENTS are most practical for edge gluing as they are light, easy to handle, quickly adjusted and efficient. Both the Style No. 2EG and Style No. 6EG Attachments have screws with deep cut ACME THREADS.

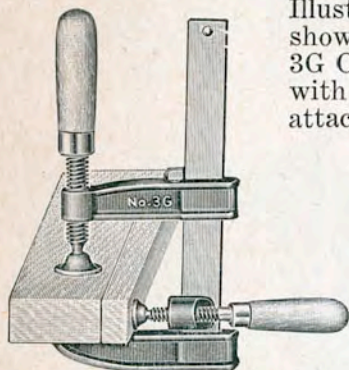
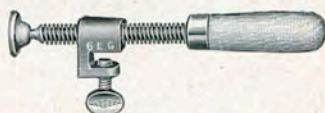

Illustration shows our 3G Clamp with 2EG attachment



EDGE CLAMP ATTACHMENTS

Specifications: Style No. 2EG Fits Clamps No. 2G and No. 3G. Screw $\frac{3}{8}$ " Diameter.

Specifications: Style No. 6EG Fits Clamps No. 3G, 4G and 6G. Screw $\frac{9}{16}$ " Diameter.

The DEEP ENGAGEMENT CLAMP is very handy for various kinds of work such as pattern making, furniture manufacture, cabinet work, welding, etc. They can be obtained in four different styles and various opening sizes as given on pages 10 and 11.

Specifications Style No. 4G

Bar size $1\frac{1}{4}$ " x $\frac{5}{16}$ "
 Reach 4"
 Clamping Surface $1\frac{1}{2}$ " Dia. Button
 Screw $\frac{11}{16}$ " Dia.
 Handle Wood or wing

Specifications Style No. 6G

Bar size $1\frac{3}{8}$ " x $\frac{3}{8}$ "
 Reach 6"
 Clamping Surface $1\frac{1}{2}$ " Dia. Button
 Screw $\frac{11}{16}$ " Dia.
 Handle Wood or wing

Style No. 4G

Stock No.	Opens	Approx. Net Wt. Doz.
4G8	8 in.	46 lbs.
4G10	10 in.	48 lbs.
4G12	12 in.	51 lbs.
4G18	18 in.	58 lbs.
4G24	24 in.	65 lbs.
4G36	36 in.	80 lbs.
4G48	48 in.	95 lbs.

Style No. 6G

Stock No.	Opens	Approx. Net Wt. Doz.
6G12	12 in.	84 lbs.
6G18	18 in.	95 lbs.
6G24	24 in.	104 lbs.
6G30	30 in.	115 lbs.
6G36	36 in.	126 lbs.
6G48	48 in.	147 lbs.
6G60	60 in.	168 lbs.

Packed one-half dozen to a carton or bundle

SEE PRICE LIST

EAST HARTFORD, CONNECTICUT

The HARTFORD

QUICK ADJUSTING, SELF-LOCKING AND UNLOCKING UNIVERSAL CLAMP

Style No. 3GU extends in 3" on the work—made with deep ACME THREADED SCREWS, high carbon steel bars and best grade malleable iron castings. These clamps are used for gluing where triple clamping is required on irregular shapes.

IRREGULAR FRAMES
CORNER WORK
MITRE WORK
CHAIRS
SOFAS
FURNITURE

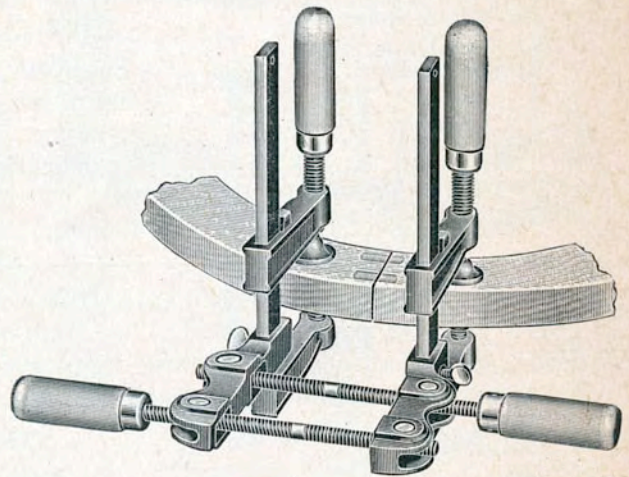

Specifications Style 3GU

Bar Size	1" x 5/16"
Reach	3"
Openings	6"
Clamping Surface	1 1/4" Dia. Button
Clamp Screws	9/16" Dia.
Handles	Wood
Weight	7 1/2 lbs.

SEE PRICE LIST

THE HARTFORD CLAMP COMPANY

The HARTFORD

QUICK ADJUSTING, SELF-LOCKING AND UNLOCKING SINGLE BAR CLAMPS (Patented)

Styles No. 16, 17 and 18 have bars of carbon spring steel—screws have deep cut ACME THREADS—castings of the best grade malleable iron. The double gripping blocks in Nos. 16 and 17 and the dog in No. 18 are carefully heat treated and hardened. These clamps are light yet very strong for their weight and are used by furniture frame manufacturers, boat builders, body builders, welders, etc.

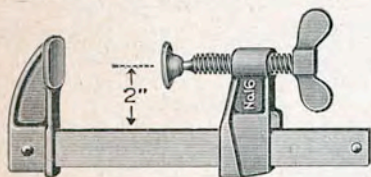

Style No. 16 has adjustable HEAD PIECE only.

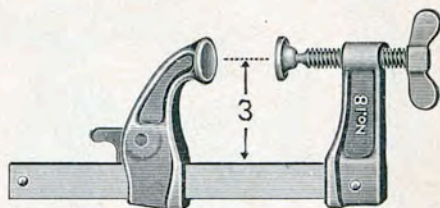

Style No. 18 has adjustable TAIL PIECE only.

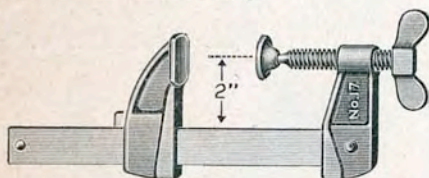

Style No. 17 has adjustable TAIL PIECE only.

Styles No. 16 and No. 17 tested for safe clamping strain of 1800 lbs.

Specifications Styles No. 16, 17 and 18

Bar size	1" x 5/16"
Reach, Nos. 16 and 17	2"
Reach, No. 18	3"
Clamping Surface	1 1/4" Dia. Button
Screw	9/16" Dia.
Handle	Wing or wood

Styles No. 16 and 17

Stock No.	Opens	Approx. Net Wt. Doz.
166 176	6 in.	30 lbs.
168 178	8 in.	32 lbs.
1610 1710	10 in.	34 lbs.
1612 1712	12 in.	36 lbs.
1618 1718	18 in.	43 lbs.
1624 1724	24 in.	49 lbs.
1630 1730	30 in.	55 lbs.
1636 1736	36 in.	62 lbs.

Style No. 18

Stock No.	Opens	Approx. Net Wt. Doz.
186	6 in.	32 lbs.
188	8 in.	34 lbs.
1810	10 in.	36 lbs.
1812	12 in.	38 lbs.
1818	18 in.	45 lbs.
1824	24 in.	51 lbs.
1830	30 in.	57 lbs.
1836	36 in.	64 lbs.

Packed one-half dozen to a carton or bundle

SEE PRICE LIST

EAST HARTFORD, CONNECTICUT

The HARTFORD

QUICK ADJUSTING, SELF-LOCKING AND UNLOCKING SINGLE BAR CLAMPS (Patented)

Styles No. 15 and No. 19 extend in 6" on the work with a good clamping strain—made with deep cut ACME THREADED SCREWS, high carbon spring steel bars and best grade malleable iron castings. Both items have **HARTFORD** double heat treated, hardened steel gripping blocks inserted firmly in the casting.

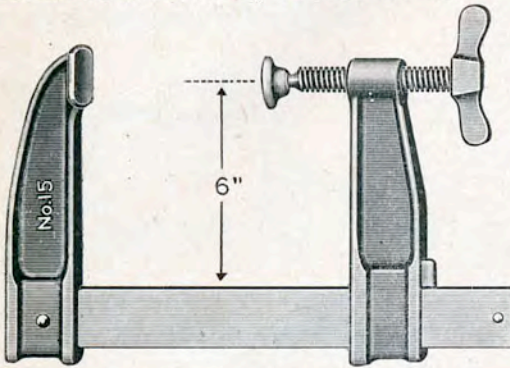

Style No. 15

This is a general purpose clamp with a safe clamping strain of 2,100 lbs.

Specifications

Bar size $1\frac{3}{4}$ " x $\frac{5}{16}$ "
 Reach 6"
 Clamping Surface $1\frac{1}{2}$ " Dia. Button
 Screw $\frac{3}{4}$ " Dia.
 Handle Wing

Style No. 19

The wide flat clamping surface has planed off jaws, and a safe clamping strain of 4,500 lbs.

Specifications

Bar size $1\frac{3}{4}$ " x $\frac{5}{16}$ "
 Reach 6"
 Clamping Surface 6" hgt. x $1\frac{3}{4}$ "
 Screw $\frac{3}{4}$ " Dia.
 Handle Wing

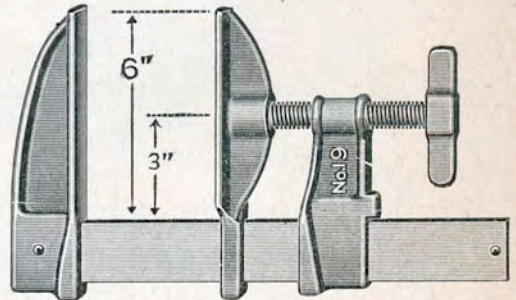

Style No. 19

Stock No.	Opens	Approx. Net Wt. Doz.
156	6 in.	84 lbs.
158	8 in.	88 lbs.
1510	10 in.	91 lbs.
1512	12 in.	95 lbs.
1518	18 in.	106 lbs.
1524	24 in.	117 lbs.
1530	30 in.	128 lbs.
1536	36 in.	140 lbs.

Stock No.	Opens	Approx. Net Wt. Doz.
196	6 in.	84 lbs.
198	8 in.	88 lbs.
1910	10 in.	91 lbs.
1912	12 in.	95 lbs.
1918	18 in.	106 lbs.
1924	24 in.	117 lbs.
1930	30 in.	128 lbs.
1936	36 in.	140 lbs.

Packed one-half dozen to a carton or bundle

SEE PRICE LIST

THE HARTFORD CLAMP COMPANY

The HARTFORD

QUICK ADJUSTING, SELF-LOCKING AND UNLOCKING SINGLE BAR CLAMPS (Patented)

Styles No. 9 and No. 20 are used extensively by boat builders, body builders, machine builders and welders to take the place of "C" Clamps, as they are quick adjusting and because the short screw will not bend out of shape. Both these clamps are very strong for their weight.

The locking mechanism instantly locks when pressure is applied and will not slip or stick—hammering or any other vibration will not loosen the locking device.

Specifications Style No. 9

Bar size	1 1/2" x 1/4"
Reach	3"
Clamping Surface	1 1/4" Dia. Button
Screw	9/16" Dia.
Handle	Wing only
Tested for safe clamping strain of 2,400 lbs.	

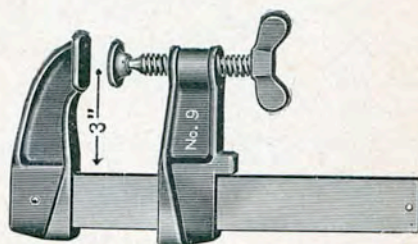

Specifications Style No. 20

Bar size	1 3/4" x 5/16"
Reach	3"
Clamping Surface	1 1/2" Dia. Button
Screw	3/4" Dia.
Handle	Wing only
Tested for a safe clamping strain of 4,500 lbs.	

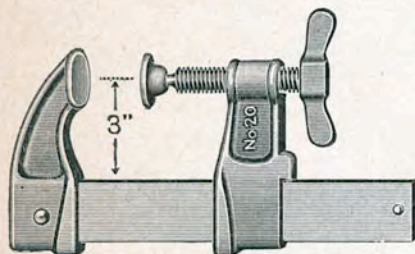

Style No. 9

Stock No.	Opens	Approx. Net Wt. Doz.
96	6 in.	42 lbs.
98	8 in.	44 lbs.
910	10 in.	47 lbs.
912	12 in.	49 lbs.
918	18 in.	57 lbs.
924	24 in.	65 lbs.
930	30 in.	72 lbs.
936	36 in.	80 lbs.

Style No. 20

Stock No.	Opens	Approx. Net Wt. Doz.
206	6 in.	66 lbs.
208	8 in.	69 lbs.
2010	10 in.	73 lbs.
2012	12 in.	77 lbs.
2018	18 in.	88 lbs.
2024	24 in.	99 lbs.
2030	30 in.	110 lbs.
2036	36 in.	122 lbs.

Packed one-half dozen to a carton or bundle

SEE PRICE LIST

EAST HARTFORD, CONNECTICUT

Page Fifteen

The HARTFORD

STYLE No. 60 WOOD BAR CLAMP FIXTURES

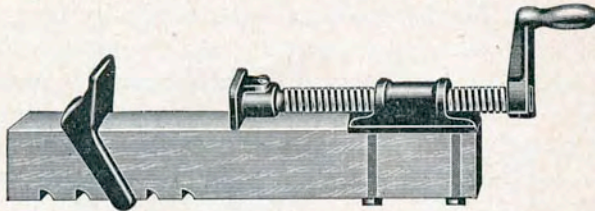

Our No. 60 Clamp Fixtures are designed to fit a wooden bar $1\frac{1}{4}$ " thick x $2\frac{1}{2}$ " wide and are easily attached. They are sold in sets consisting of the complete head and tail piece, without the wooden bar, which when assembled makes a very handy clamp. Screws are $\frac{11}{16}$ " cold drawn steel with ACME THREADS. Castings are of the best refined malleable iron.

	Approx. Net Wt. Doz.
Fixtures	40 lbs.
Head only (screw end)	35 lbs.
Packed $\frac{1}{2}$ Dozen Sets per Carton	

The HARTFORD

STYLE No. 61 PRESS SCREW

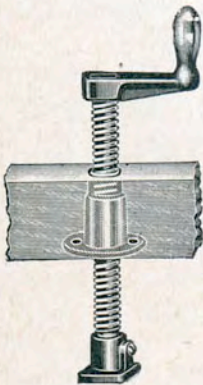

These Press Screws are used by concerns that make up their own light wooden glue or frame assembling presses. The nut is inserted in a $1\frac{1}{16}$ " hole and firmly held in place with wood screws.

Castings are of the best refined malleable iron, screws are $\frac{11}{16}$ " with deep cut ACME THREADS.

Sketch shows 12" Press Screw, handle, push plate and nut assembled.

Packed $\frac{1}{2}$ dozen per carton

SEE PRICE LIST

THE HARTFORD CLAMP COMPANY

The HARTFORD

ADJUSTABLE STEEL SPINDLE HAND SCREWS

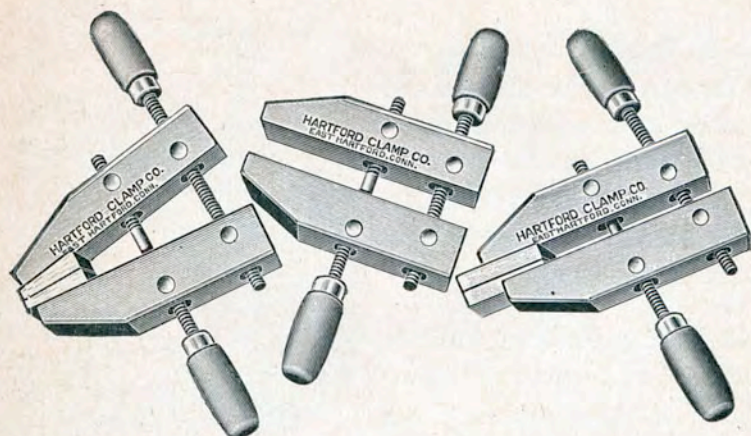

HAND SCREW SPECIFICATIONS

The jaws are of straight grain, HARD MAPLE properly seasoned and oiled.

The handles are of smooth HARD MAPLE with extra heavy steel ferrules that hold fast.

The spindles and nuts are of COLD-DRAWN STEEL with smooth cut threads.

All "HARTFORD" Hand Screws are given final inspection before packing to insure perfection.

<i>Cat. No.</i>	<i>Length of Jaws</i>	<i>Opening Between Jaws</i>	<i>Approx. Net. Wt. Per Doz.</i>
H206	6 in.	3 in.	13 lbs.
H208	8 in.	4½ in.	24 lbs.
H210	10 in.	6 in.	31 lbs.
H212	12 in.	8½ in.	51 lbs.
H214	14 in.	10 in.	61 lbs.
H216	16 in.	12 in.	89 lbs.
H218	18 in.	14 in.	100 lbs.

Packed ½ dozen per carton. Please order by Catalog Number

SEE PRICE LIST

EAST HARTFORD, CONNECTICUT

Page Seventeen

The HARTFORD

STYLE No. 63 DOUBLE SCREW BAND CLAMP

Our No. 63 Band Clamp, designed especially for barrel chair frames and irregular chair frames, is the ideal tool for this work, as it holds the frame securely for nailing and screwing and can be easily placed on and off the work by one man.

By cutting out a block of wood to fit the front of your chair, whether it be round or straight, and notching the wood to accommodate the clamp (See cuts) you will have a very powerful clamp which will simplify this otherwise difficult task.

To adjust this clamp to either a small or large chair, simply move the band casting to another hole in the bar.

The malleable iron castings to which the band is fastened will fit any clamp having bar measuring $1\frac{1}{2}$ " x $\frac{1}{4}$ " and can be purchased without the screw ends or bars. Therefore, providing you have a pair of such clamps, all that is necessary is to drill a few holes in the bars by which to fasten the band casting.

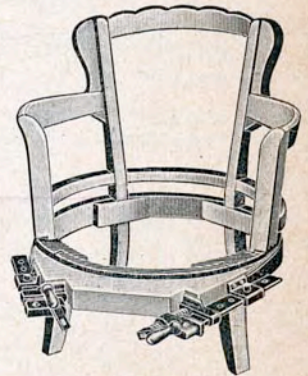
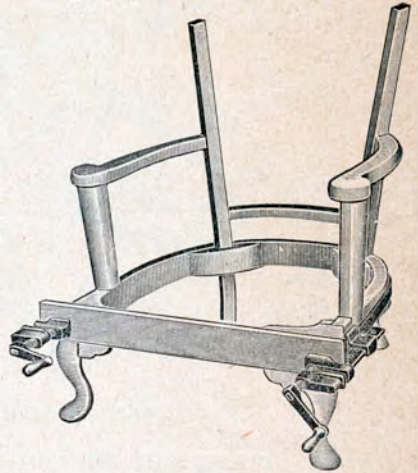

SEE PRICE LIST

THE HARTFORD CLAMP COMPANY

The HARTFORD

STYLE No. 75 COLUMN CLAMP

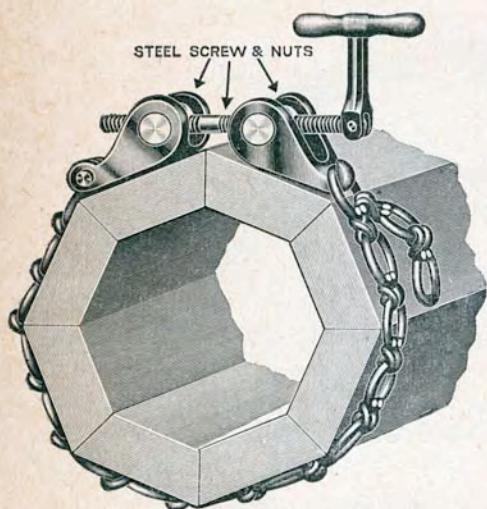

This Column Clamp has a $\frac{5}{8}$ " cold drawn steel screw with left and right hand threads for quick action. The nuts and chain are of steel, castings are of the best refined malleable iron.

<i>Opens</i>	<i>Approx. Net Wgt. per Doz.</i>
4 ft.	48 lbs.

Extra chain

See Price List

When ordering specify length of chain.

Packed $\frac{1}{2}$ dozen per carton.

STYLE No. 62 MITRE CLAMP

Our Mitre Clamps have planed off jaws with hardened steel pins just long enough to hold the work. The small holes made by the pins are hardly noticeable. Work can be brought up square and firm by operating the eccentric lever—used to a large extent for window and door casings. Castings are of the best refined malleable iron. There is no quicker clamp made for this purpose.

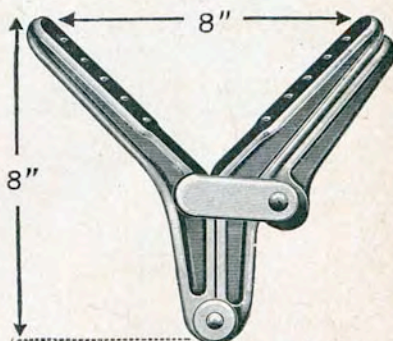

Mitre Clamp—approximate net weight per dozen, 20 lbs.

Packed one-half dozen to a carton

SEE PRICE LIST

EAST HARTFORD, CONNECTICUT

Page Nineteen

The HARTFORD

QUICK ADJUSTING, SELF-LOCKING AND UNLOCKING
RADIUS CLAMP (Patented)

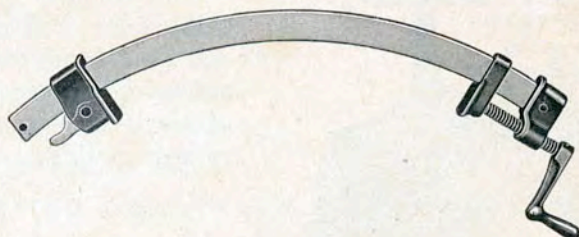

These Circle or Radius Clamps are used by most casket manufacturers for gluing oval panel casket tops as shown in the cut below, also used in furniture manufacturing, and can be obtained in our **Style No. 1** Clamp having bar 1" x 5/16" or our **Style No. 5** Clamp having bar 1 1/2" x 1/4" in most any radius with loose or one piece malleable iron crank handle.

For patented locking device and other specifications see Page 3.

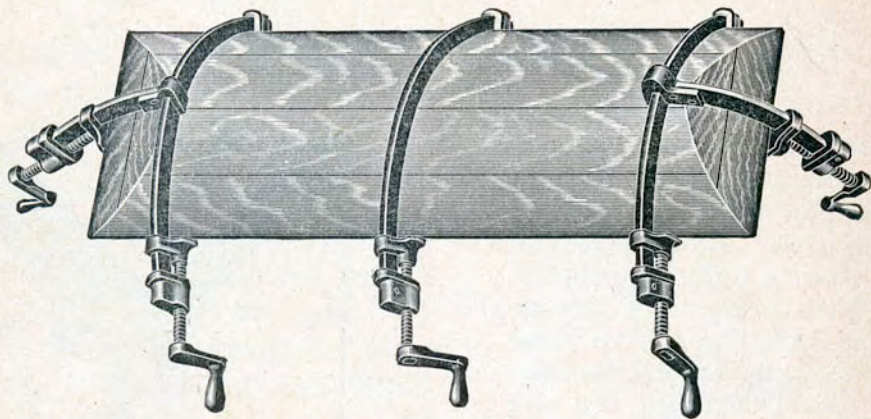

Illustration shows oval casket top with three radius clamps and two end clamps.

When ordering Radius Clamps please send us a full size sketch or template showing radius and opening size.

SEE PRICE LIST

THE HARTFORD CLAMP COMPANY

When Ordering

Be sure to specify either Stock No. or Style No., OPENING size of clamp desired and type of handle, thus avoiding delay and unnecessary mistakes.

All claims for errors or shortages must be made upon receipt of goods.

We are not responsible for loss of goods or damages received in transit.

Full shipping instructions are requested; if none are given, we will ship according to our best judgment.

TERMS 30 days net or less 2% discount for payment 10th of month following date of shipment.

F. O. B. East Hartford 8, Conn., unless otherwise specified.

Guarantee

We guarantee these clamps to be absolutely free from all defects in workmanship and materials, and will gladly furnish free of charge, any parts which at any time may prove defective provided the defective parts are returned to us for inspection.

We are not responsible for delays resulting from fires, strikes or other causes beyond our control.

THE

